



n° 151

**overvoltages
and insulation
coordination in
MV and HV**

D. Fulchiron

Having graduated from the Ecole Supérieure d'Electricité in 1980, he joined Merlin Gerin in 1981 working in the High Power Testing Station (VOLTA) until 1987.

He then joined the technical department of the Medium Voltage Division in which he is currently project manager. His involvement in secondary distribution equipment studies has led him to examine insulation coordination more thoroughly.

The author would like to thank:

Florence Bouchet

A student at the Supelec Institute who, as trainee, helped to produce this document.

Jean Pasteau

Member of the Technical Management who provided his competence as expert contributing to the revision of standard IEC 71.

overvoltages and insulation coordination in MV and HV

contents

1. Overvoltages	Power frequency overvoltages	p. 4
	Switching overvoltages	p. 5
	Lightning overvoltages	p. 8
2. Insulation coordination	Definition	p. 11
	Clearance and voltage withstand	p. 11
	Withstand voltage	p. 12
	Insulation coordination principle	p. 13
3. Overvoltage protective devices	Dischargers	p. 14
	Surge arresters	p. 14
4. Standards and insulation coordination	HV insulation coordination as in IEC 71	p. 17
5. Coordination applied to electrical installation design	Breakdown consequences	p. 20
	Reduction of overvoltage risks and level	p. 20
6. Conclusion		p. 21
Appendix 1: propagation of overvoltage		p. 21
Appendix 2: installing a surge arrester	Maximum safety clearance	p. 22
	Cabling the surge arresters	p. 22
Appendix 3: electricity standards		p. 23
Appendix 4: bibliography		p. 24

Insulation coordination is a discipline aiming at achieving the best possible technico-economic compromise for protection of persons and equipment against overvoltages, whether caused by the network or lightning, occurring on electrical installations.

It helps ensure a high degree of availability of electrical power.

Its value is doubled by the fact that it concerns high voltage networks. To control insulation coordination:

- the level of the possible overvoltages occurring on the network must be known;
- the right protective devices must be used when necessary;
- the correct overvoltage withstand level must be chosen for the various network components from among the insulating voltages satisfying the particular constraints.

The purpose of this "Cahier Technique" is to further knowledge of voltage disturbances, how they can be limited and the standards to ensure safe, optimised distribution of electrical power by means of insulation coordination. It deals mainly with MV and HV.

1. overvoltages

These are disturbances superimposed on circuit rated voltage. They may occur:

- between different phases or circuits. They are said to be differential mode;
- between live conductors and the frame or earth. They are said to be common mode.

Their varied and random nature makes them hard to characterise, allowing only a statistical approach to their duration, amplitudes and effects. The table in figure 1 presents the main characteristics of these disturbances.

In point of fact, the main risks are malfunctions, destruction of the equipment and, consequently, lack of continuity of service. These effects may occur on the installations of both energy distributors and users.

Disturbances may result in:

- short disconnections (automatic reclosing on MV public distribution networks by overhead lines);
- long disconnections (intervention for changing damaged insulators or even replacement of equipment). Protective devices limit these risks. Their use calls for careful drawing up of consistent insulation and protection levels. For this, prior understanding of the various types of overvoltages is vital: such is the purpose of this chapter.

power frequency overvoltages

This term includes all overvoltages with frequencies under 500 Hz.

Reminder: the most common network frequencies are: 50, 60 and 400 Hz.

Overvoltage caused by an insulation fault (see fig. 2)

An overvoltage due to an insulation fault occurs on a three-phase network when the neutral is unearthed or impedance-earthed.

In actual fact, when an insulation fault occurs between a phase and the frame or earth (a damaged underground

cable, earthing of an overhead conductor by branches, equipment fault, ...), the phase in question is placed at earth potential and the remaining two phases are then subjected, with respect to earth, to the phase-to-phase voltage

$$U = V \sqrt{3}.$$

More precisely, when an insulation fault occurs on phase A, an earth fault factor, S_d , is defined by the ratio of the voltage of phases B and C with respect to earth, to network phase to neutral voltage.

The following equation is used to calculate S_d :

$$S_d = \frac{\sqrt{3} (k^2 + k + 1)}{k + 2}$$

$$\text{where } k = \frac{X_o}{X_d}$$

X_d is the direct reactance of the network seen from the fault point, and X_o the zero sequence reactance.

Note that:

- if the neutral is completely unearthed,

$$X_o = \infty; S_d = 3^{1/2} = \sqrt{3};$$

- if the neutral is completely earthed, $X_o = X_d; S_d = 1;$

- if, as in the general case, $X_o \leq 3 X_d; S_d \leq 1.25.$

Overvoltage on a long off-load line (Ferranti effect)

An overvoltage may occur when a long line is energised at one of its ends and not connected at the other. This is due

overvoltage type (cause)	MV-HV over voltage coefficient	term	steepness of frequency front	damping
at power frequency (insulation fault)	$\leq \sqrt{3}$	long > 1 s	power frequency	low
switching (short-circuit disconnection)	2 to 4	short 1 ms	medium 1 to 200 kHz	medium
atmospheric (direct lightning stroke)	> 4	very short 1 to 10 μ s	very high 1,000 kV/ μ s	high

fig. 1: characteristics of the various overvoltage types.

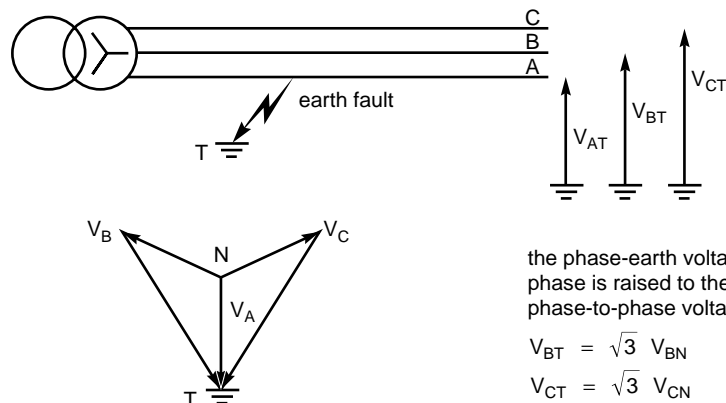

the phase-earth voltage of fault-free phase is raised to the value of the phase-to-phase voltage:

$$V_{BT} = \sqrt{3} V_{BN}$$

$$V_{CT} = \sqrt{3} V_{CN}$$

fig. 2: temporary overvoltage on an unearthed neutral network in presence of an insulation fault.

to resonance which takes the form of a voltage wave increasing in linear fashion along the line.

In point of fact, where:

- L and C refer to line inductance and total capacity respectively;
- U_s and U_e are the voltages at the open end and at line entrance, the overvoltage factor equals:

$$\frac{U_s}{U_e} = \frac{1}{1 - \frac{L C \omega^2}{2}}$$

This overvoltage factor is around 1.05 for a 300 km line and 1.16 for a 500 km line. These values are more or less the same for HV and EHV lines.

This phenomenon is particularly common when a long line is suddenly discharged.

Overvoltage by ferromagnetic resonance

In this case the overvoltage is the result of a special resonance which occurs when a circuit contains both a capacitor (voluntary or stray) and an inductance with saturable magnetic circuit (e.g. a transformer). This resonance occurs particularly when an operation (circuit opening or closing) is performed on the network with a device having poles either separate or with non-simultaneous operation.

The circuit shown in the diagram in figure 3, with connected in series a saturable core inductance, L, and the network capacitance, C, makes it easier to understand the phenomenon. The following three curves can then be drawn: $U_c = f(i)$, $U_L = f(i)$ and $(U_L - 1 / C \omega i) = f(i)$;

- the first one is a straight sloping line $1 / C \omega$;
- the second one presents a saturation bend;
- and the third one displays two operating points (O and B) for which voltage at the terminals of the LC assembly is zero, and two other stable operating points, M and P; N is an unstable point of balance. The voltages at the terminals of L and C (point P) are high. Move from M to P may be due only to a transient temporarily raising voltage e to a value greater than E.

These overvoltages (see the diagram in figure 3) present a risk of dielectric breakdown and a danger for any loads

parallel-connected on C. However, more generally, the powers involved are fairly low ($1/2 C V^2$ with low C) and only likely to damage fragile equipment. It is up to the equipment designer to evaluate and limit this risk.

Notes:

Ferromagnetic resonance, depending on variable L, may occur for a wide frequency band.

A similar demonstration can be made for parallel resonance.

A load connected to the circuit acts as a reducing resistance and prevents maintenance of resonance conditions.

switching overvoltages

Sudden changes in electrical network structure give rise to transient phenomena frequently resulting in the creation of an overvoltage or of a high frequency wave train of aperiodic or oscillating type with rapid damping.

Normal load switching overvoltage

A «normal» load is mainly resistive, i.e. its power factor is greater than 0.7. In this case, breaking or making of load currents does not present a major problem. The overvoltage factor (transient voltage amplitude/operating voltage ratio) varies between 1.2 and 1.5.

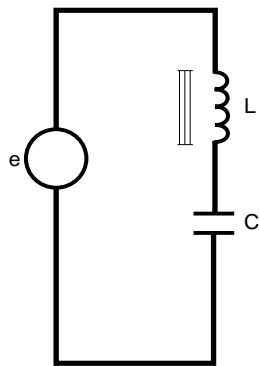

diagram

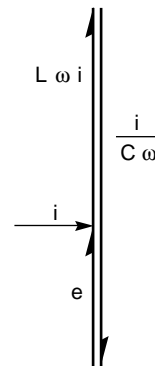

vectorial representation

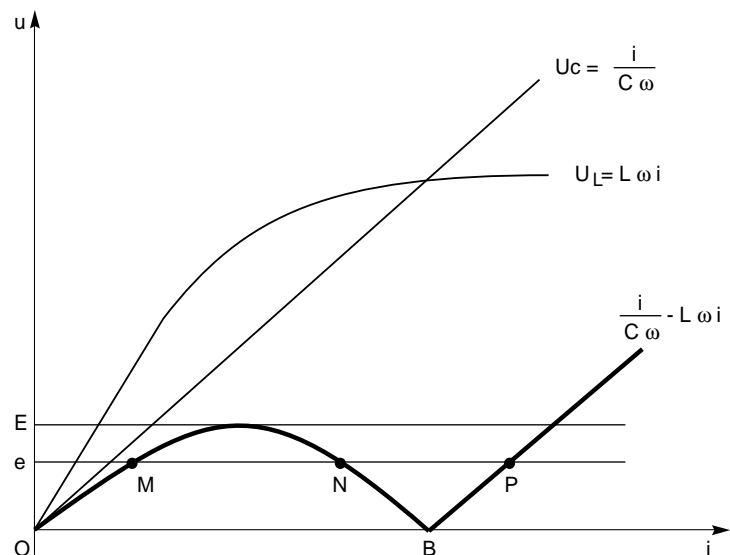

fig. 3: ferromagnetic resonance principle..

Overvoltages caused by making and breaking of small inductive currents

This type of overvoltage is caused by three phenomena: current pinch-off, rearing and prearcing.

The diagram in figure 4 shows a network supplying a load through a circuit-breaker. It contains:

- a sinusoidal voltage source with an inductance, L_1 and a capacitance, C_1 ,
- a circuit-breaker, D, which cannot be dissociated from its stray elements, L_{p1} and C_{p1} ,
- an inductive load, L_2 , the distributed capacitance of which cannot be overlooked, symbolised by a capacitor, C_2 ,
- finally, a line inductance, L_0 , generally negligible.

■ current pinch-off

The arc occurring on breaking of low currents, in particular less than circuit-breaker rated current, takes up little space. It undergoes considerable cooling due to the circuit-breaker's capacity to break far higher currents.

It thus becomes unstable and its voltage may present high relative variations, whereas its absolute value remains far below network voltage (case of breaking in SF6 or vacuum).

These e.m.f. variations may generate oscillating currents (see fig. 4) of high frequency in the adjacent capacitances, both stray and voluntary. The amplitude of these currents can become non-negligible with a 50 Hz current and reach 10 % of its value.

Superimposition of the 50 Hz current and of this high frequency current in the circuit-breaker will result in the current moving to zero several times around the zero of the fundamental wave (see fig. 5).

The circuit-breaker, little affected by these low currents, is often capable of breaking at the first current zero occurring. At this moment, the currents in the generator and load circuits are not zero. The instantaneous value, i , of the 50 Hz wave on arc extinguishing is known as the «pinched-off current».

The energy trapped in the circuit varies according to the type of impedances involved, mainly resistive and inductive. Small inductive currents (see fig. 4) present a load with a high inductance which, when the arc is extinguished, will have an energy given by:

$$\frac{1}{2} L_2 I^2.$$

The $L_2 C_2$ circuit is now in the slightly damped, free oscillation state, and the peak value V of the voltage occurring at the terminals of C_2 is approximated by the energy conservation hypothesis:

$$\frac{1}{2} L_2 I^2 = \frac{1}{2} C_2 V^2.$$

If C_2 is only made up of stray capacitances with respect to frames, the value of V may present a risk for equipment insulation (circuit-breaker or load).

The generator circuit has an equivalent behaviour, but its inductance is generally much smaller and the voltages occurring at the terminals of C_1 are thus far lower.

■ rearing

This occurs when the pinching-off phenomenon described above causes an input-output overvoltage to occur at the terminals of the circuit-breaker unable to be withstood by the latter: an arc then occurs. This simplified explanation is complicated by the

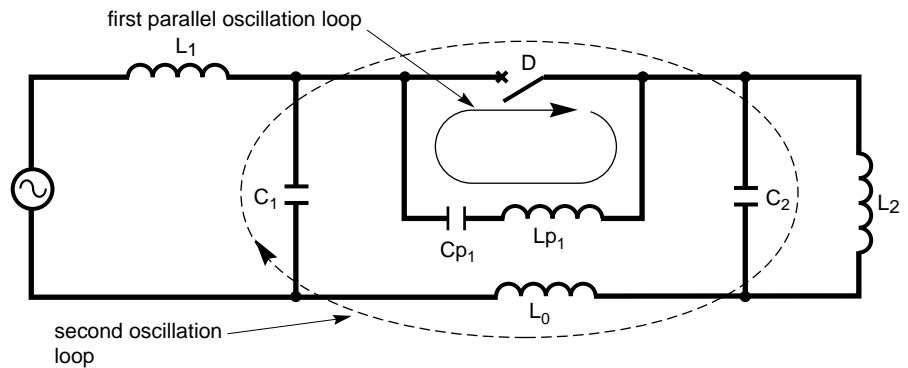

fig. 4: equivalent circuit for the study of overvoltages caused by inductive current breaking where:

- C_{p1} : circuit-breaker capacitance,
- L_{p1} : circuit-breaker inductance.

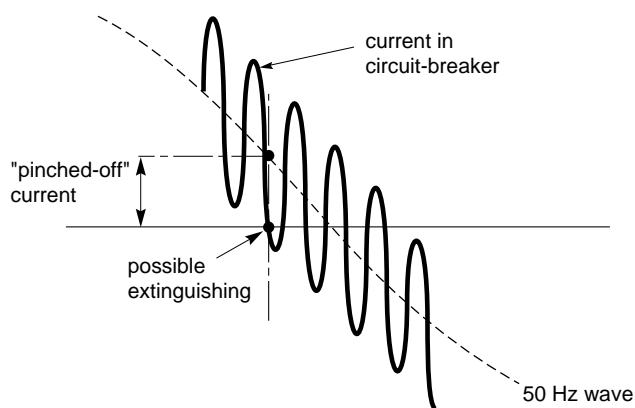

fig. 5: superimposition of a high frequency oscillating current on a power frequency current.

presence of the stray elements presented above.

In actual fact, following current breaking and rearing, three oscillating phenomena occur simultaneously at the respective frequencies F_{p1} , F_{p2} and F_m :

- in the loop
- D - L_{p1} - C_{p1} :

$$F_{p1} = \frac{1}{2 \pi \sqrt{L_{p1} C_{p1}}}$$

of around a few MHz.

- in the loop
- D - C_1 - L_0 - C_2 :

$$F_{p2} = \frac{1}{2\pi} \sqrt{\frac{C_1 + C_2}{L_0 C_1 C_2}}$$

of around 100 to 500 kHz.

- throughout the circuit,

$$F_m = \frac{1}{2\pi} \sqrt{\frac{L_1 + L_2}{L_1 L_2 5 (C_1 + C_2)}}$$

of around 5 to 20 kHz.

Multiple rearing then occurs (chopping) until it is stopped by increasing contact clearance. This rearing is characterised by high frequency wave trains of increasing amplitude. These overvoltage trains upstream and downstream from the circuit-breaker can thus present a considerable risk for equipment containing windings.

This phenomenon must not be confused with «reignition» which is the reappearance of a power frequency current wave and thus a breaking failure on the current wave zero.

■ prearcing

When a device closes (switch, contactor or circuit-breaker), there is a moment when dielectric withstand between contacts is less than applied voltage. In the case of rapidly closing devices, with respect to 50 Hz, behaviour depends on the phase angle during operation.

An arc is then created between the contacts, and the circuit witnesses a voltage pulse due to the sudden cancellation of voltage at the device terminals. This pulse may result in

oscillation of existing parallel circuits (surging discharge of stray capacitances) and reflections on impedance failures, and hence in the appearance of high frequency currents, with respect to 50 Hz, through the arc.

If device operation is slow compared with this phenomenon, the arcing current may be made to move through zero by superimposition of the high frequency current and the incipient 50 Hz current.

Extinguishing of the arc, according to equipment characteristics, will then result in a behaviour similar to that described for the phenomena above. However, since dielectric withstand between contacts decreases with closing, the successive overvoltages decrease right up to complete closing.

This phenomenon is extremely complex. The resulting overvoltages depend, among other factors, on:

- circuit-breaker characteristics (dielectric properties, capacity to break high frequency currents, ...),
- characteristic cable impedance,
- load circuit natural frequencies.

Overvoltages, extremely hard to calculate, cannot generally be predetermined since they involve uncalculable elements which vary from site to site. They also require a sophisticated mathematical model of the arc chute.

Prearcing overvoltages particularly affect, in HV and MV, off-load transformers on energising and motors on starting (see Merlin Gerin "Cahier Technique" n° 143).

Overvoltage caused by switching on capacitive circuits

Capacitive circuits are defined as circuits made up of capacitor banks, and off-load lines.

■ energising of capacitor banks

When capacitor banks are energised, normally without initial load, and in the case of slow operating devices, arcing occurs between the contacts around the 50 Hz wave peak.

Damped oscillation of the LC system in figure 6 then occurs. The frequency of this oscillation is generally far higher than power frequency, and voltage

oscillation is mainly centered around the 50 Hz wave peak value. The maximum voltage value observed is then around twice the 50 Hz wave peak value.

In the case of faster operating devices, arcing does not systematically occur around the peak value: the overvoltage, if any, is thus lower.

If a capacitor bank is put back into operation very soon after it has been disconnected from the network, its residual load voltage is between zero and the 50 Hz wave peak voltage. Arcing between contacts occurs around a peak of opposite polarity (breakdown under a stress twice peak voltage). The oscillation described above occurs with a double initial pulse. The maximum voltage value observed may then be close to three times the 50 Hz peak voltage.

For safety reasons, capacitor banks are always fitted with discharging resistors able to eliminate residual voltages with time constants of around one minute. Consequently, an overvoltage factor of 3 corresponds to very specific cases.

■ energising of off-load lines or cables
Slow closing of a device on this type of load causes, in this case also, arcing around the 50 Hz peak: the voltage step applied to one end of the line or cable will spread and be reflected on the open end (see appendix 1).

Superimposition of the incident step and the reflected step results in a voltage stress twice the applied step, give or take the dampings, and assuming that the 50 Hz can be likened to DC for these phenomena.

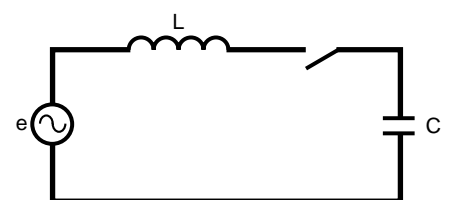

fig. 6: schematic diagram showing a capacitor operating circuit.

As this type of behaviour is related to the distributed inductances and capacitances of the conductors considered, overhead lines present, in addition, a phase-to-phase coupling making modelling relatively complex.

This reflection phenomenon must be taken into consideration particularly in (EHV) transmission lines, as a result of the small relative difference between operating voltage and insulating voltage.

■ capacitive circuit breaking

Breaking of capacitive circuits normally presents few difficulties. In point of fact, as capacitances remain charged at the 50 Hz wave peak value, after the arc is extinguished at current zero, voltage is resumed at the equipment terminals at 50 Hz with no transients. However, one alternation after breaking, the device is subjected to an input output voltage twice peak voltage.

If it is unable to withstand this stress (e.g. opening not yet sufficient), reignition may occur. This is followed, provided the circuit so allows (single-phase or connected neutral circuit) by voltage inversion at capacitor terminals, raising them to a maximum load of three times peak voltage (see fig. 7). The current breaks yet again and a new reignition may take place with a value five times peak voltage at the next alternation.

Such behaviour may result in considerable escalation and must be avoided by choosing equipment which prevents reignition.

lightning overvoltages

A storm is a natural phenomenon well known to all, and which is both spectacular and dangerous.

On average 1,000 storms break out each day throughout the world. In France, (see fig. 8), they cause each year 10 % of fires, the death of 40 people and 20,000 animals and 50,000 electricity or phone cuts.

Overhead networks are those most affected by lightning overvoltages and overcurrents.

Lightning strokes are characterised by their polarisation: they are generally negative (negative cloud and positive ground). Roughly 10 % have reversed polarity, but these are the most violent.

Note that the rising front of lightning strokes chosen by standards is 1.2 μs for voltage and 8 μs for current.

A distinction is often made between:

■ «direct» lightning strokes striking a line;

■ «indirect» lightning strokes, falling next to a line, on a pylon or, which comes to the same, on the earth cable (this cable, earthed, connects the tops of pylons and protects live conductors from direct lightning strokes).

Direct lightning strokes

This results in the injection of a current wave of several dozens of kA in the line. This current wave, which may cause conductors to melt by propa-gating on either side of the point of impact (see fig. 9) results in an increase in voltage U given by the formula:

$$U = Zc \frac{i}{2}$$

where i is the injected current and Zc the characteristic line zero sequence impedance (300 to 1,000 ohms).

U then reaches values of several million volts, which no line can withstand. At a point in the line, for example at the first pylon the wave meets, voltage increases until clearance breakdown occurs (insulator string). According to whether or not arcing has occurred (depending on the value of the current injected into the line), the wave which continues to propagate after the pylon is said to be broken or full.

For various network voltages, arcing does not occur below the critical current indicated by the straight line in figure 10.

For networks with a voltage less than 400 kV, virtually all direct lightning strokes result in arcing and an earth fault.

In actual fact, it is estimated that only 3 % of overvoltages, observed on the French 20 kV MV public network, exceed 70 kV and are thus ascribable to direct lightning strokes. Moreover, as a result of attenuation of the voltage

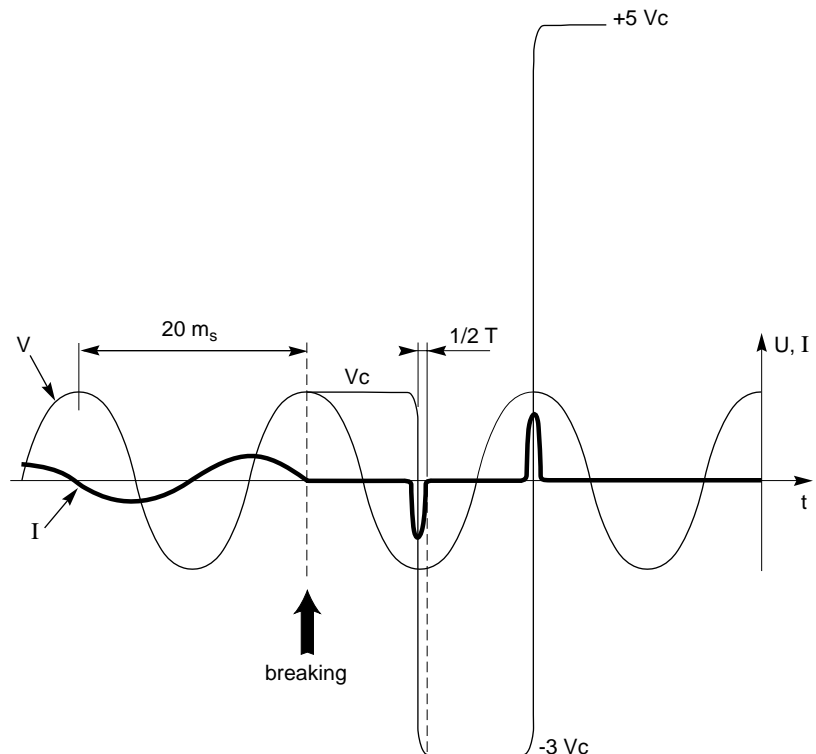

fig. 7: voltage escalation on separation of a capacitor bank from the network by a slow operating device.

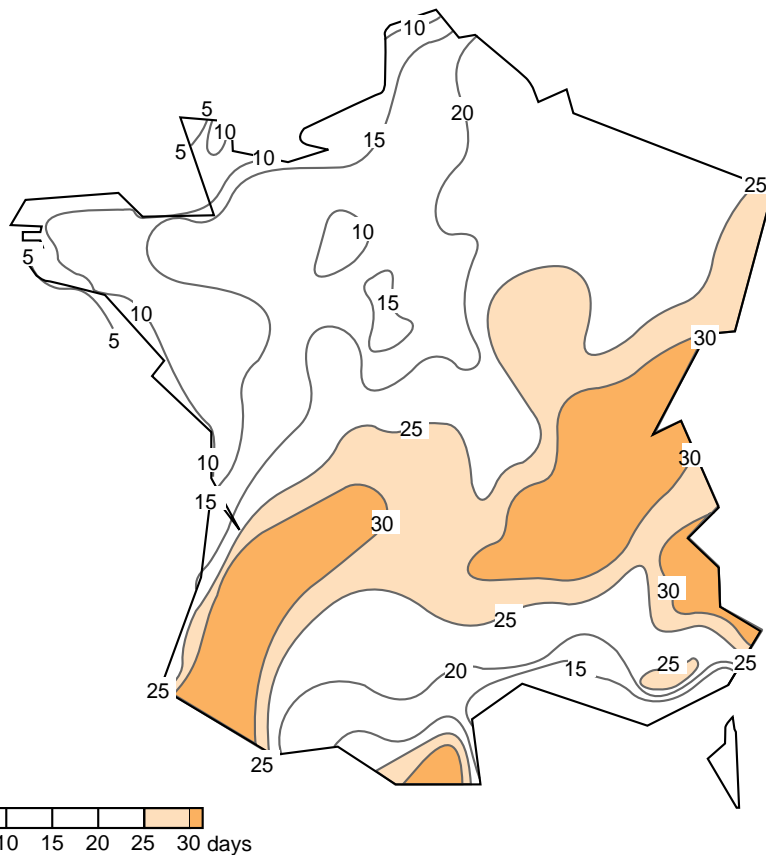

fig. 8: isokeraunic levels in continental France (graduated in annual mean number of stormy days).
Source: Météorologie Nationale.

$$U = Zc \cdot i/2$$

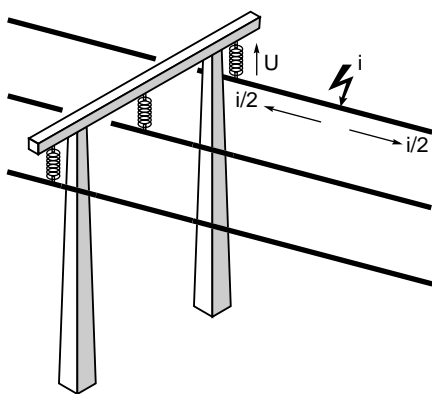

fig. 9: when lightning strikes directly, the current wave propagates on either side of the point of impact.

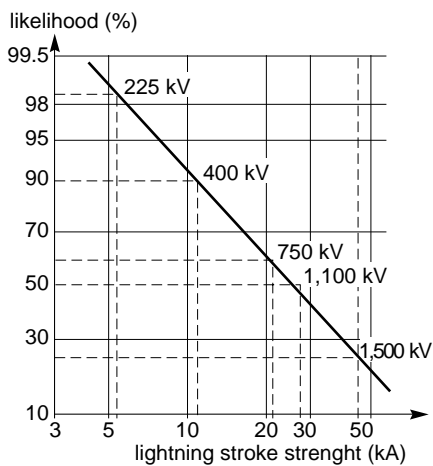

fig. 10: statistical distribution of the strength of direct lightning strokes and minimum arcing strengths as a function of network voltage level.

wave throughout its propagation along the line, maximum overvoltages (very rare) at the entrance of a substation or building are estimated at 150 kV in MV.

It should be remembered that the highest impulse withstand of 24 kV equipment is 125 kV.

Indirect lightning strokes

When indirect strokes fall on a support or even simply next to a line, high overvoltages are generated in the network.

Indirect strokes, more frequent than direct ones, may prove almost as dangerous.

■ if lightning falls on the pylon or the earth cable, the current flowing off causes an increase in metal frame potential with respect to earth (see fig. 11). The corresponding overvoltage U may reach several hundreds of kV.

$$U = R \frac{i}{2} + \frac{L}{2} \frac{di}{dt}$$

where R is the earth connection steep wave resistance and L is the inductance of the pylon and/or the earthing conductor.

$$U = R \frac{i}{2} + \frac{L}{2} \frac{di}{dt}$$

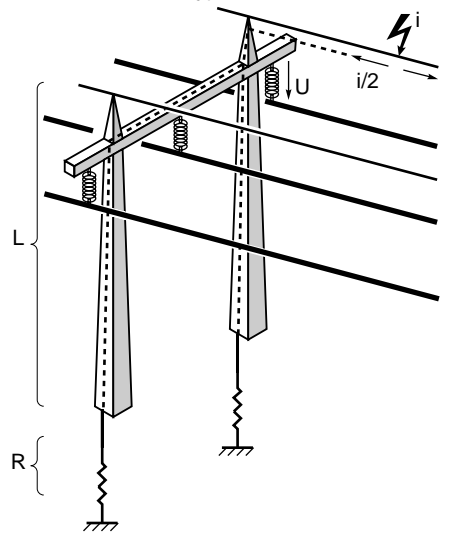

fig. 11: when lightning falls on the earth cable, current evacuation causes an increase in the potential of the pylon metal frame with respect to earth.

When this voltage reaches the arcing voltage of an insulator, an «arcing return» occurs between the metal structure and one or more of the live conductors.

In the case of network voltages greater than 150 kV, this arcing return is unlikely. The quality of pylon earth connections plays an important role.

From 750 kV onwards, there is virtually no more risk of arcing return, thus justifying the installation of earth cables on EHV lines. Below 90 kV, these cables only provide efficient protection if the pylon earth connection is excellent.

■ if lightning falls next to the line, the energy flowing off to the ground causes a very fast variation of the electromagnetic field. The waves induced on the line are similar in shape and amplitude to those obtained by direct lightning. They are mainly characterised by their very steep front (around one micro-second) and their very fast damping (whether or not aperiodic) (typical characteristics of these waves as in standard IEC 60: front time: $1.2 \mu\text{s}$ and tail time: $\approx 50 \mu\text{s}$).

■ when the voltage wave resulting from a lightning stroke passes through a MV / LV transformer, transmission mainly occurs by capacitive coupling. The amplitude of the overvoltage thus transmitted, observed on the secondary winding on the LV side, is less than 10 % of its value on the MV side (generally less than 70 kV). Therefore,

on LV lines, induced overvoltages are generally less than 7 kV.

A statistical observation, retained by the French electrotechnical committee, revealed that 91 % of overvoltages occurring at LV consumers did not exceed 4 kV and 98 % did not exceed 6 kV (see fig. 12). This accounts, for example, for the connection circuit-breaker manufacturing standard which stipulates an impulse withstand of 8 kV.

Electrostatic overvoltages

Other types of atmospheric discharges exist. Indeed, although the majority of induced overvoltages are electromagnetic in origin, some are electrostatic and concern in particular unearthed networks.

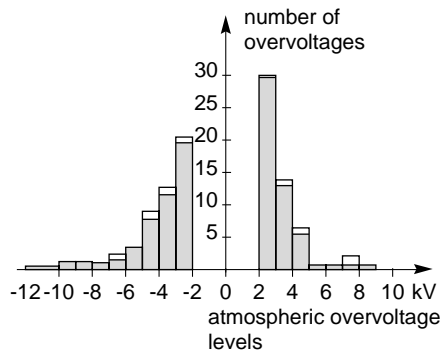

fig. 12: statistical distribution of atmospheric overvoltage amplitude drawn up from two observation campaigns (183 between 1973 and 1974, and 150 in 1975), hence duplication of curves.

For example, in the minutes preceding a lightning stroke, when a cloud charged at a certain potential is placed above a line, this line takes on a charge of opposite direction (see diagram in figure 13).

Before the lightning strikes, thus discharging the cloud, an electric field, E, thus exists between the line and the ground which can reach 30 kV/m. Under the effect of this field, the line/earth capacitor is charged to a potential of around 150 to 500 kV according to how high the line is from the ground.

Unenergetic breakdown may then occur in the least well insulated components of the network.

When arcing occurs between the cloud and the earth, since the electric field has disappeared, the capacitances discharge.

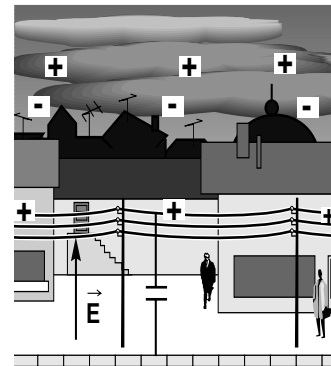

fig. 13: origin of an electrostatic overvoltage.

2. insulation coordination

The first electrical networks (Grenoble-Jarrie 1883) were technologically extremely rudimentary and at the mercy of atmospheric conditions such as wind and rain:

- wind, by causing inter-conductor clearance gaps to vary, was responsible for arcing;
- rain encouraged current leaks to earth.

These problems resulted in:

- use of insulators;
- determination of clearances;
- earthing of metal frames of devices.

definition

The purpose of insulation coordination is to determine the necessary and sufficient insulation characteristics of the various network components in order to obtain uniform withstand to normal voltages and to overvoltages of various origins (see fig. 14). Its final objective is to ensure safe, optimised distribution of electrical power.

By «optimised» is meant finding the best possible economic balance between the various parameters depending on this coordination:

- cost of insulation;
- cost of protective devices;
- cost of failures (operating loss and repairs) in view of their probability.

The first step towards removing the detrimental effects of overvoltages is to confront the phenomena generating them: a task which is not always simple. Indeed, although equipment switching overvoltages can be limited by means of suitable techniques, it is impossible to have any effect on lightning.

It is thus necessary to locate the point of least withstand through which the current generated by the overvoltage will flow, and to equip all the other network elements with a higher level of dielectric withstand.

Before presenting the various technical solutions (methods and equipment), a

reminder will be given of the definitions of clearance and withstand voltage.

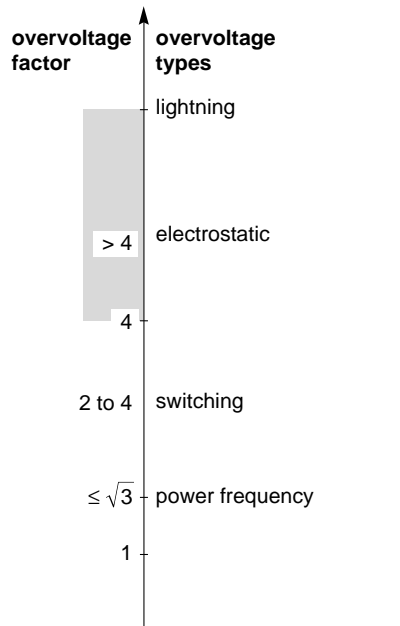

fig. 14: various voltage levels present on MV-HV networks.

clearance and voltage withstand

Clearance

This term covers two notions: «gas clearance (air, SF6, etc...) and «creepage distance» of solid insulators (see fig. 15):

- gas clearance is the shortest path between two conductive parts;
- creepage distance is also the shortest path between two conductors, but following the outer surface of a solid insulator (this is known as creepage).

These two clearances are directly related to the concern with overvoltage protection, but do not have identical withstand.

Voltage withstand

This varies in particular according to the type of overvoltage applied (voltage level, rising front, frequency, time...).

Moreover, creepage distances may be subjected to ageing phenomena, specific to the insulating material in question, causing deterioration of their characteristics.

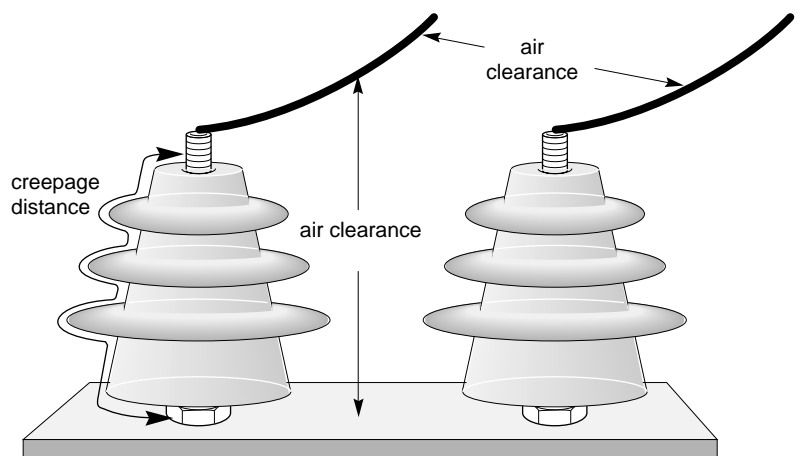

fig. 15: air clearance and creepage distance.

The main influencing factors are:

- environmental conditions (humidity, pollution, UV radiation);
- permanent electrical stresses (local value of electric field).

Gas clearance withstand also depends on pressure:

- variation of air pressure with altitude;
- variation of device filling pressure.

withstand voltage

In gases, insulation withstand voltage is a highly nonlinear function of clearance. For example, in air, a root mean square voltage stress of 300 kV/m is acceptable under 1 m, but can be reduced to 200 kV/m between 1 and 4 m and to 150 kV/m between 4 and 8 m. It should also be pointed out that this clearance is practically unaffected by rain.

This macroscopic behaviour is due to the lack of uniformity of the electric field between electrodes of all shapes and not to intrinsic gas characteristics. It would not be observed between flat electrodes of «infinite» size (uniform field).

Creepage distances of busbar supports, transformer bushings and insulator strings are determined to obtain a withstand similar to direct air clearance between two end electrodes when they are dry and clean. On the other hand, rain and especially wet pollution considerably reduce their withstand voltage.

Power frequency withstand

In normal operating conditions, network voltage may present short duration power frequency overvoltages (a fraction of a second to a few hours: depending on network protection and operating mode). Voltage withstand checked by the standard one-minute dielectric tests is normally sufficient. Determination of this category of characteristics is simple, and the various insulators are easy to compare. For example, figure 16 provides a comparison of voltage withstands between air and SF6 as a function of pressure.

Switching impulse voltage withstand

Clearances subjected to switching impulses have the four following main properties:

- nonlinearity, mentioned above, in the clearance/voltage relationship;
- dispersion, which means withstand must be expressed in statistical terms;
- unbalance (withstand varies according to whether wave polarity is positive or negative);
- passage through a minimum curve value of the withstand voltage as a function of front time. When the gap between electrodes increases, this minimum value moves to increasingly higher front times (see fig. 17). On average it is around 250 μ s which accounts for the choice of standard test voltage rising front (standard tests as in IEC 60: application of a wave of front time 250 μ s and half-amplitude time 2,500 μ s).

Lightning overvoltage withstand

In the case of lightning, withstand is characterised by far greater linearity than for the other stress types.

Dispersion is present in this case also with a positive polarity withstand (the «+» applied to the most pointed electrode) inferior to that of negative polarity.

The two following simple formulas enable withstand to a 1.2 μ s/50 μ s positive polarity impulse of an air gap to be evaluated for EHV and MV networks:

$$\blacksquare U_{50} = \frac{d}{1.9}$$

U_{50} = voltage for which breakdown likelihood is 50 %;

$$\blacksquare U_0 = \frac{d}{2.1}$$

U_0 = withstand voltage where d is clearance in metres U_{50} and U_0 are in MV.

A large number of experimental studies have made it possible to draw up precise correspondence tables between clearance and withstand voltage, taking into account a variety of factors such as front and tail times, environmental pollution and insulator type.

To give an example, figure 18 shows the variations in voltage U_{50} as a function of clearance and tail time T_2 for a positive peak-plane interval.

Moreover, table T in figure 19 shows that withstand voltage does not depend on rising front time.

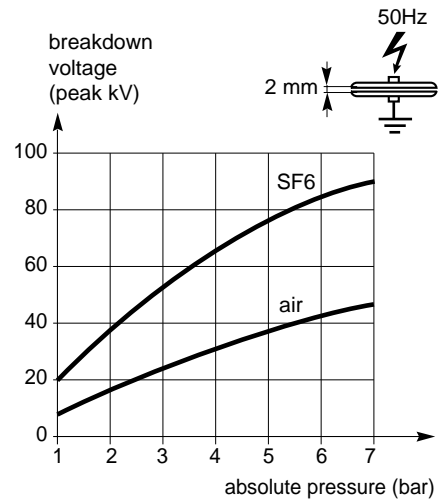

fig. 16: SF6 and air breakdown voltage as a function of absolute pressure.

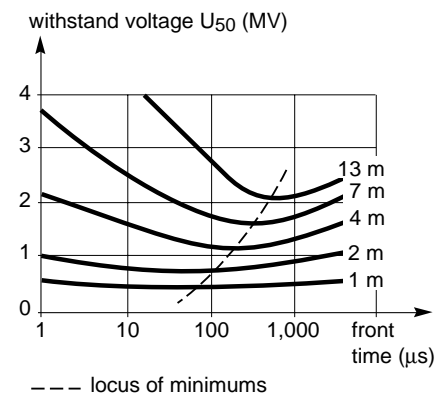

fig. 17: line showing minimum withstand values as a function of front time of impulse applied in positive polarity.

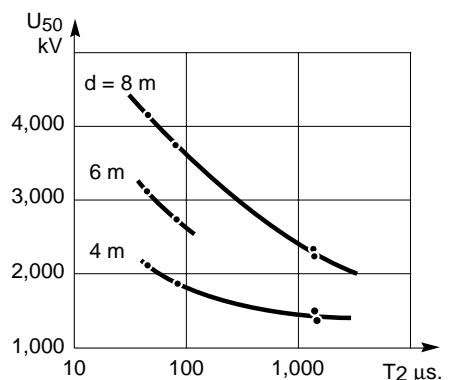

fig. 18: U_{50} as a function of time T_2 decreasing at half-amplitude. Intervale between the positive peak and the plane: d = 4 - 6 - 8 m.

T_{cr} (μs)	7	22
T_2 (μs)	1,400	1,500
U_{50} (kv)	2,304	2,227
σ	370	217

fig. 19: influences of time up to the peak on dielectric withstand of a positive peak-plane interval = $d = 8 m$.

insulation coordination principle

Study of insulation coordination of an electrical installation is thus the definition, based on the possible voltage and overvoltage levels on this installation, of one or more overvoltage protection levels. Installation equipment and protective devices are thus chosen accordingly (see fig. 20).

Protection level is determined by the following conditions:

- installation;

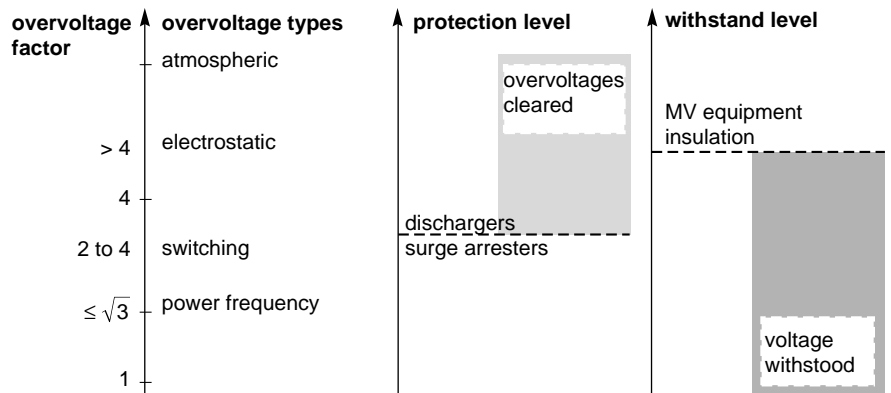

fig. 20: insulation coordination: correctly protection level and equipment withstand as a function of probable overvoltages.

- environment;
- equipment use.

Study of these «conditions» determines the overvoltage level to which the equipment could be subjected during use. Choice of the right insulation level will ensure that, at least as far as power frequency and switching impulses are concerned, this level will never be overshoot.

As regards lightning, a compromise must generally be found between insulation level, protection level of arresters, if any, and acceptable failure risk.

Proper control of the protection levels provided by surge limiters requires thorough knowledge of their characteristics and behaviour: this is the purpose of the following chapter.

3. overvoltage protective devices

Dischargers and surge arresters are the devices used to clip and limit high amplitude transient overvoltages. They are normally designed so that they can deal with lightning overvoltages.

dischargers

Used in MV and HV, they are placed in particularly exposed network points and at the entrance to MV/LV substations. Their function is to create a weak point controlled in network insulation so that any arcing will systematically occur just there.

The first and oldest protective device is the point discharger. It consisted of two points facing each other, known as electrodes, one connected to the conductor to be protected and the other to the earth.

The most common current models use the same principle but contain two «horns» to elongate the arc, simplify restoration of dielectric qualities by deionising the arcing gap and, in certain cases, to extinguish the arc.

In addition, some models are fitted with a rod, between these two electrodes, designed to prevent untimely «short-circuiting» by birds (see fig. 21) and their electrocution.

The gap between the two electrodes enables adjustment of protection level. Although this device is simple, fairly efficient and economical, it has many drawbacks:

- arcing voltage is considerably dispersed and depends to a large extent on atmospheric conditions: variations of more than 40 % have been observed;
- arcing level also depends on overvoltage amplitude (see fig. 22);
- arcing delay increases as overvoltage decreases.

In these conditions, an impulse voltage may cause arcing of a device with a withstand voltage greater than that of the discharger, for the simple reason that this device has a smaller arcing delay (e.g. cables).

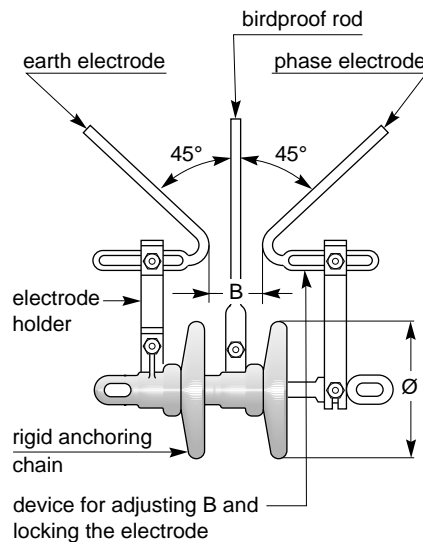

fig. 21: a MV discharger with birdproof rod e.g. on EDF 24 kV networks, $B \approx 25$ mm.

Moreover, after arcing, ionisation between the electrodes maintains the arc which is then supplied by network voltage and may give rise (according to neutral earthing) to a power frequency retaining current. This current is a full earth fault and requires intervention of the protective devices placed at the front of the line (e.g. rapid reclosing circuit-breaker or shunt circuit-breaker).

Finally, arcing causes the appearance of a steep front broken wave which could damage the windings (transformers and motors) placed nearby.

Although still used in networks, dischargers are today increasingly replaced by surge arresters.

surge arresters

Arresters have the advantage of having no retaining current and of preventing

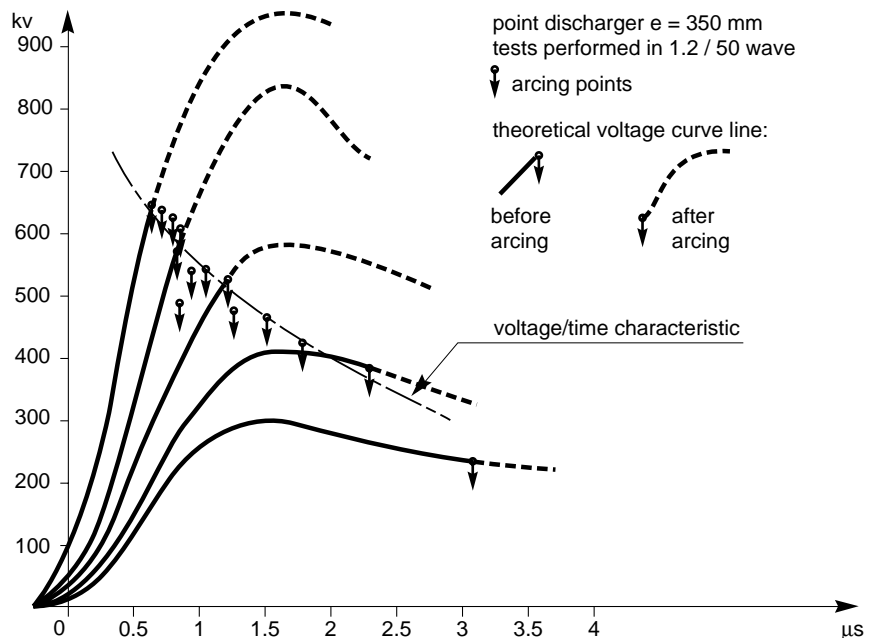

fig. 22: behaviour of a point discharger in standard lightning impulse, as a function of peak value.

the network from being short-circuited and then de-energised after arcing. A variety of models have been designed: water stream arrester, gas arrester... Only the most common types are presented in the paragraphs below. These arresters are used on HV and MV networks.

Nonlinear resistance arresters and air gap protectors

This arrester type connects in series air gap protectors and nonlinear resistances (varistors) able to limit current on occurrence of a surge.

Once the discharging current wave has flown off, the arrester is only subjected to network voltage. This voltage maintains an arc on the air gap protector, but the corresponding current, known as the «retaining current» flows through the resistance whose value is now high. It is thus sufficiently low not to damage the air gap protector and to be cleared when the current moves to zero for the first time (the arc is naturally extinguished).

Nonlinearity of resistances maintains a residual voltage which appears at the terminals of the device, close to arcing level, since resistance decreases as current increases.

A variety of techniques have been used to produce varistor arresters and air gap protectors. The most classical kind uses a silicon carbide (SiC) resistance.

Some arresters also contain voltage distribution systems (resistive or capacitive dividers) and arc blowing systems (magnets or coils for magnetic blowing).

This type of arrester is characterised by:

- its extinction voltage or rated voltage, which is the highest power frequency voltage under which the arrester can be spontaneously de-energised. It must be greater than the highest short duration power frequency overvoltage which could occur on the network;
- its arcing voltages according to wave shape (power frequency, switching impulse, lightning impulse....); they are statistically defined;

■ its impulse current evacuation capacity, i.e. its energy dissipation capacity. Absorption capacity is generally given by withstand to rectangular current waves.

Zinc oxide (ZnO) arresters

Made up only of varistors, they are increasingly replacing nonlinear resistance arresters and air gap protectors (see fig. 23).

Absence of air gap means that ZnO arresters are permanently conductive, but under protected network rated voltage, have a very small earth leakage current (less than 10 mA). Their operating principle is very simple, based on the highly nonlinear characteristic of ZnO varistors. This nonlinearity is such that resistance decreases from 1.5 M Ω to 15 Ω

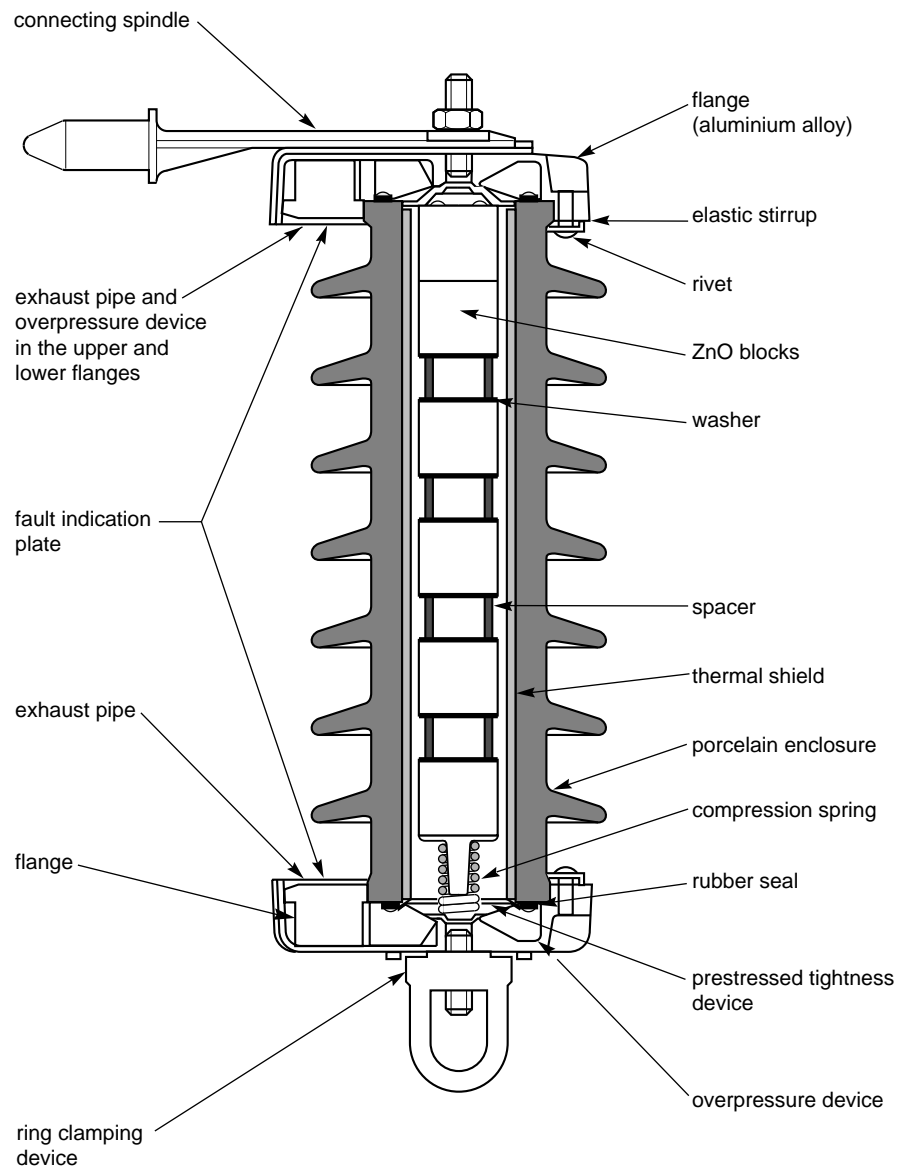

fig. 23: example of the structure of a ZnO arrester in a porcelain enclosure for the EDF 20 kV network.

between operating voltage and voltage at rated discharging current (see fig. 24).

The advantage of these arresters is their increased limitation and reliability compared with silicon carbide arresters. Improvements have been made in recent years, in particular in the thermal and electrical stability field of ZnO pellets on ageing.

Thus in 1989 only two failures were observed on 15,000 surge arresters of this type installed by EDF after eighteen months' experimentation. No changes were noted in the characteristics, checked by tests.

ZnO arresters are characterised by (see fig. 25):

- their maximum permanent operating voltage;
- their rated voltage which may be linked, by analogy with silicon carbide arresters, to withstand to temporary overvoltages;

- the protection level, defined arbitrarily as the residual voltage of the arrester subjected to a given current impulse (5, 10 or 20 kA according to class), 8/20 μ s wave;
- rated discharging current;
- impulse current withstand. (this refers to the need for withstand to long waves causing considerable energy dissipation and not to the need to flow off such currents in operation).

Enclosure

Zinc oxide arresters are available:

- in porcelain enclosures for nearly all operating voltages;
- in synthetic enclosures (glass fibre plus resin) for distribution networks.

The second technique, more recent, has produced arresters which are far lighter, less vulnerable to vandalism and with better live part protection against humidity since they are completely compound-filled. In point of

fact, humidity is the main cause of failure identified on the ZnO arresters. The outside of these arresters is generally made up of silicon polymer providing environmental resistance and reconstitution of sufficient creepage distances. Their internal composition and silicon enclosures mean that these arresters can be placed in far more positions with optimisation of implementation (e.g.: horizontal mounting).

In addition to EDF specifications such as HN 65S20 / IEC 99-1, a variety of French standards apply to arresters, e.g. the NF C 65-100 for HV installation devices.

In conclusion, these various arrester types are used for protection of equipment, transformers and cables. In this case, practically all the arresters used are zinc oxide ones which are gradually replacing horn gaps and silicon carbide arresters.

The purpose of this evolution is increased accuracy of protection levels to guarantee insulation coordination to a even higher degree.

Readers interested in implementation of arresters can refer to appendix 2.

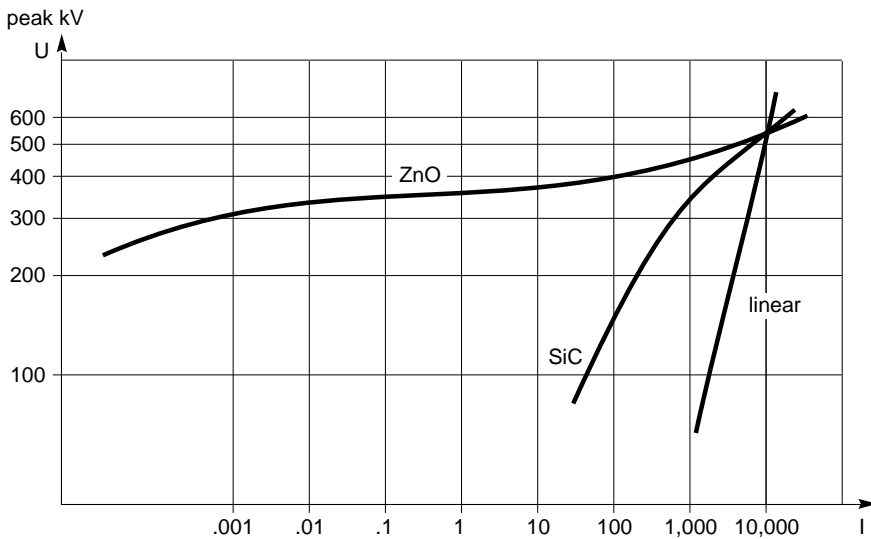

fig. 24: characteristics of two arresters with the same level of protection 550 kV/10 kA peak kV.

■ maximum permanent voltage	12.7 kV
■ rated voltage	24 kV
■ residual voltage at rated discharging current	< 75 kV
■ rated discharging current (8/20 μ s wave)	5 kA
■ impulse current withstand (4/10 μ s wave)	65 kA

fig. 25: example of characteristics of a ZnO arrester meeting specification EDF HN 65S20.

4. standards and insulation coordination

For many years now the International Electrotechnical Commission (IEC) has been concerned with the problem of HV insulation coordination.

Insulation coordination is dealt with in two main documents:

- IEC 664 for LV;
- IEC 71 for HV.

IEC 71 is divided into two parts, the second part forming an exhaustive application guide.

«Product» standards, including:

- IEC 694 «common clauses for equipment»;
 - IEC 76 «transformers»;
 - IEC 99 «surge arresters»;
- comply with IEC 71 as regards specific withstand voltages.

HV insulation coordination as in IEC 71

One of the objectives of this standard which should come into force in 93 is to explain and break down the various factors for achievement of withstand voltages. This approach encourages search for optimisation and even reduction in voltage withstand levels.

Standard IEC 71 proposes conventional modelling of actual stresses by wave

shapes producible in laboratories and having shown satisfactory equivalence. Moreover, two new concepts are dealt with in this standard:

- longitudinal insulation (between the terminals of the same phase of an open device);
- consideration of altitude and of installation ageing.

This draft-standard distinguishes internal insulation, external insulation and two voltage ranges:

- internal insulation covers everything not in ambient air (for example, liquid insulation for transformers, SF6 or vacuum for circuit-breakers);
- external insulation refers to air clearances.
- range I: from 1 kV to 245 kV inclusive
- range II: above 245 kV.

For each of these, implementation of insulation coordination varies slightly.

A table of standardised rated withstand voltages exists for each range. These tables have been drawn up according to various criteria, and, although mostly empirical up to now, have been confirmed, with a few reservations, by experience. Indeed, it cannot be denied that the levels laid down, which have not been changed for years, are fully

acceptable as regards operating safety. Moreover, the gradual replacement of dischargers by arresters enables reduction of the safety margin which had become superfluous between arrester protection level and equipment specified insulating voltage.

Determining insulation levels

The standard does not stipulate invariable withstand voltages valid in all cases, but enables insulation coordination studies to be carried out in a number of stages:

- definition of relationships between network type and choice of its insulations.

The purpose is to establish the characteristics of the maximum possible permanent voltages and the foreseeable temporary overvoltages as a function of:

- network structure and its rated voltage,
 - the neutral earthing connection diagram,
 - the substations and rotating machines present on the line,
 - the type and position of surge limitation devices, if any,
- and according to considerations common to all overvoltage classes defined by the standard (see fig. 26).

overvoltage class	low frequency		transient		
	permanent	temporary	slow front	fast front	very fast front
shape					
shape range (frequency, rising front, term)	f = 50 or 60 Hz T_t ≥ 3,600 s	10 < f < 500 Hz 3,600 ≥ T_t ≥ 0.03 s	5,000 > T_p > 20 μs 20 ms ≥ T_2	20 > T_1 > 0.1 μs 300 μs ≥ T_2	100 > T_f > 3 ns 0.3 > f_1 > 100 MHz 30 > f_2 > 300 kHz 3 ms ≥ T_t
standardised shape	f = 50 or 60 Hz T_t (*)	48 ≤ f ≤ 62 Hz T_t = 60 s	T_p = 250 μs T_2 = 2,500 μs	T_1 = 1.2 μs T_2 = 50 μs	(*)
standardised withstand test	(*)	short duration power frequency test	switching impulse test	lightning impulse test	(*)

(*) to be specified by the relevant product Committee

fig. 26: representative overvoltage shapes and tests considered by draft-standard IEC 71.

■ coordination of network insulation
Once these data have been collected, the corresponding coordination withstand voltage must be determined for each overvoltage class taking into consideration the required performance and, generally, the acceptable insulation failure rate. The value obtained is specific to the network studied and to its situation and is the lowest withstand voltage to the overvoltage in question that the network has to have in its operating conditions.

To choose the components of a network, their specified withstand voltages must be defined.

Determination of coordination withstand voltages consists in setting the minimum values of the insulation withstand voltages satisfying performance criterion when insulation is subjected to the representative overvoltages in operating conditions.

Determination of specified insulation withstand voltages consists in converting the coordination withstand voltages into appropriate standardised test conditions. This is achieved by multiplying the coordination withstand voltages by factors compensating the differences between actual insulation operation conditions and standardised withstand test conditions.

Rated insulation level is chosen by selecting the most economical series of standardised insulation withstand voltages, sufficient to prove that all the specified withstand voltages are satisfied.

The study chart for final determination of rated insulation is shown in figure 27. This chart covers the two factors, altitude and manufacturing dispersion, defined in the draft-standard, by the term of corrective factor.

■ rated withstand voltage or insulation level is the same as specified withstand voltage for overvoltages which can be tested, i.e.:

- power frequency test,
- switching impulse test,
- lightning impulse test.

■ the equivalence factors proposed by standard IEC 71 mean generally that only two withstand voltages need be specified out of the 3 considered.

For operating voltages under 245 kV, the power frequency test and the lightning impulse test are the ones normally chosen.

■ the final choice is made from standardised levels (see fig. 28) from all the rated voltages.

An example:

Figure 29 presents a calculation of this kind taken from the application guide of the draft-revision of publication IEC 71. It shows the insulation coordination study for a substation characterised by the highest voltage for the equipment $U_m = 24$ kV.

This example mainly deals with external insulation, as the chief problem facing installation and network

designers is the sizing of external insulations. Whereas use of SF6 for insulation and of the vacuum or SF6 for the breaking gap means that internal dielectric withstand is clearly determined and not dependent on environmental conditions (climate, altitude, degree of moisture, pollution,...).

Rated insulation levels to be retained:

- 50 kV at power frequency meets rated withstand voltage at low frequency permanent overvoltages (32 kV) and at more than 81 % rated withstand voltage at slow front transients (61 kV by equivalence);
- 125 kV chosen as a technico-economic compromise for fast front transients, results in:

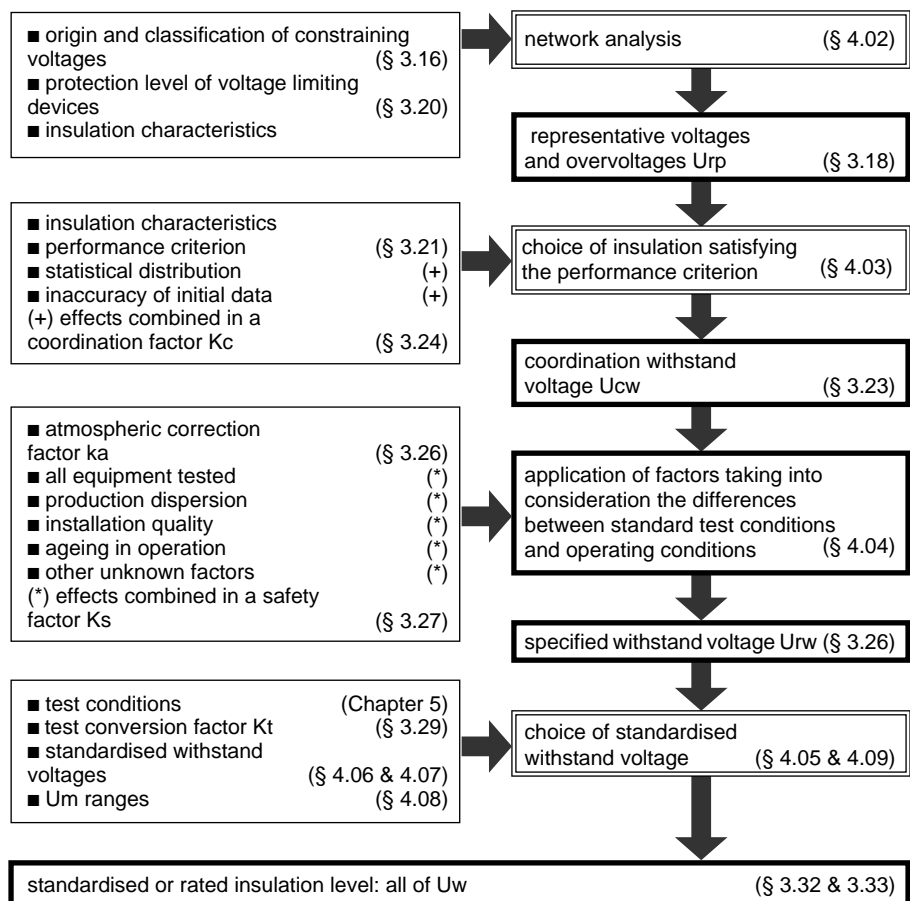

fig. 27: organisation chart for determining rated and standardised insulation levels.
Notes: between brackets, paragraphs of IEC 71 where the term is defined or the action described.

- data to be considered.
- actions to be performed.
- results obtained.

- either acceptance of a failure rate greater than that already taken as an hypothesis,
 - or addition of arresters to the installation to ensure the latter is not stressed beyond this level.
- For high and extra high voltages, the insulation coordination procedure is the same, but equipment insulation is generally qualified by its switching impulse and lightning impulse withstands.

highest voltage for equipment Um kV rms	standardised short duration withstand voltage at power frequency kV rms	standardised withstand voltages to lightning impulses kV rms
3.6	10	20/40
7.2	20	40/60
12	28	60/75/95
17.5	38	75/95
24	50	95/125/145
36	70	145/170
52	95	250
72.5	140	325
123	(185)/230	450/550
145	(185)/230/275	(450)/550/650
170	(230)/275/325	(550)/650/750
245	(275)/(325)/360/395/460	(650)/(750)/850/950/1050

fig. 28: standardised insulation levels for root mean square voltage networks between 1 and 245 kV (there is a similar table for voltages greater than 245 kV).

rated withstand voltage kV	at short duration power frequency		to lightning impulses		
rated withstand voltage to lightning impulses			74	108	141
equivalence factor slow front → fast			1.06	1.06	
rated withstand voltage to an overvoltage at short duration power frequency	28	32	42	61	
equivalence factor slow front → 50 Hz			0.6	0.6	
specified withstand voltage					
withstand voltage	28	32	70	102	141
altitude correction			1.13	1.13	1.13
dispersion factor	1.15	1.15	1.05	1.05	1.05
coordination withstand voltage (case of equipment subjected to atmospheric pressures)	24	28	59	86	119*
overvoltages in operation					
conventional representative impulse shape	short duration 50 Hz power frequency (1 mn)		250-2,500 μs impulse 2 % arcing		1.2-50 μs impulse
conventional representative amplitude (kV)	24	28	59 (2.6 p.U.)	86 (3.86 p.U.)	
overvoltage categories	phase / frame	phase to phase	phase / frame	phase to phase	phase / frame and phase to phase
	temporary at power frequency		slow front (switching)		fast front (lightning)

*: this value comes from the following criteria:
 - arrester protection level: 80 kV
 - arrester/equipment clearance: 8 m
 - safety factor: 1.05

Calculation example:
 for a slow front coordination withstand voltage of 59 kV
 ■ slow front specified withstand voltage = 59 kV x 1.05 x 1.13 = 70 kV
 ■ equivalent rated withstand voltage at standard short term frequency = 70 kV x 0.6 = 42 kV
 ■ equivalent rated withstand voltage to lightning impulses = 70 kV x 1.06 = 86 kV.

fig. 29: example of an insulation coordination study for a 24 kV network, with external insulation equipment (taken and adapted from the draft-revision of IEC 71).

5. coordination applied to electrical installation design

The high operating voltage involved increases the economic importance of this study.

Three criteria justify this statement:

- increase of number of customers or of distributed power;
- increase of failure cost (cost of equipment to be replaced);
- the smaller relative part of the coordination study in total installation cost.

breakdown consequences

Dielectric failure (breakdown or arcing) can cause:

- tripping of the protective devices in the best possible case;
- destruction of equipment in the worst possible case;
- interruption of operation each time a failure occurs.

In HV, the resulting power failure can affect an entire town, a region or an iron and steel plant, and causes:

- a risk of network destabilisation;
- a loss of energy billed for the energy distributor;
- production loss for industrial consumers;
- a risk for people (e.g. in hospitals) and for computer data.

To avoid such incidents, studies must be conducted for each new installation to provide consistent and optimised risk protection.

One solution is to increase installation insulation level by increasing clearances. However, this results in considerable increase in cost: doubling these clearances means multiplying eight times volumes and costs. Oversizing is therefore unacceptable in HV, which accounts for the importance of optimising HV equipment.

In MV

The consequences of insulation faults on MV networks are the same, on a lesser scale, as those in HV.

The consequences of the resulting electricity failures can also be serious

for energy distributors (invoice losses), industrial consumers (production losses) and people (safety).

In LV

In practice, the lower the operating voltage, the more limited the consequences of breakdown in power distribution terms. However development of electronic equipment and systems is responsible for a large number of incidents further to overvoltages. In point of fact, disturbance withstand level is not always specified or is not coordinated with the level corresponding to its installation.

However, these systems play an increasingly large role in the integrity of installations, production and management, and the economic consequences for the company concerned can be serious.

Coordination of «withstands» is thus vital, even in LV...

.... and the use of arresters should be generalised. Today they are highly recommended for LV consumers supplied by overhead lines.

reduction of overvoltage risks and level

Simple solutions to the various overvoltages looked at in chapter 1 can be considered as from the initial project of installation.

Overvoltage due to ferromagnetic resonance

The only means of removing this completely is for $1/C \omega$ to be greater than the slope at the origin of $L \omega i$. However, other solutions can be considered, in particular in MV where

- an unbalance between the 3 phases can occur in the case of protection by phase by phase controlled switch. The greatest simultaneity possible must be sought on closing the 3 network phases (omnipole equipment);
- closing an off-load transformer may be the transient phenomenon causing

ferromagnetic resonance. To prevent this, the capacitances must be reduced by approaching, for example, the transformer energising equipment.

Connection of a load prior to energising is useful since this load acts as a reducing resistance which can prevent resonance.

Earthing the neutral is also a solution for phase/earth resonances.

Overvoltage caused by capacitive current breaking

The solution is to prevent successive reignitions by increasing contact separation speed and using a good dielectric (vacuum or SF6).

Overvoltage caused by closing off-load lines

This is prevented on transmission networks by progressive energising, obtained by adding insertion resistances to the circuit-breaker.

Overvoltage caused by lightning stroke

There are three possibilities:

- installation of earth cables to prevent direct impulses (see chapter 1);
- installation of protective devices at vulnerable points (dischargers or, preferably, arresters), (see appendix 2);
- creation of good quality earth connections (see chapter 1).

6. conclusion

Insulation coordination aims at finding the right balance between equipment reliability from a dielectric standpoint, on the one hand, and their sizing and thus cost, on the other.

The presentation made in this document shows the complexity of the parameters involved in such an analysis.

Moreover, the statistical aspect of behaviour to transient overvoltages

rules out the possibility of absolute solutions.

Although the modellings chosen may appear somewhat arbitrary at first sight, they have been confirmed by experience.

More detailed information can be found in the publications quoted for readers wishing to examine the subject in greater depth. The progress made in knowledge of phenomena now ensures increased installation reliability

alongside optimisation of economy and electrical operating stresses.

Increasing use of arresters, partly due to improvement of their characteristics and reliability, contributes to greater control of protection levels. Consideration of this aspect by international standard committees, both generally and as regards product recommendations, is proof of the importance of the subject and of its associated advantages.

appendix 1: propagation of overvoltage

Whatever the origin of the overvoltage, it will propagate along the line or cable making up the network.

This propagation support can be modelled by using values per length unit of inductance and resistance in longitudinal and of capacitance and conductance in transverse (see fig. 30). The impedance, in sinusoidal state, is then given by:

$$Z = \sqrt{\frac{L \omega + R}{C \omega + G}}$$

At the high frequencies generally associated with overvoltages, the inductive and capacitive terms become preponderant. The impedance known as "characteristic impedance" then equals:

$$Z_c = \sqrt{\frac{L}{C}}$$

The resistive and conductive terms correspond to losses causing wave attenuation during its propagation.

The magnitudes of the characteristic impedances are:

- EHV lines: 300 to 500 ohms;
- HVA lines (overhead); approximately 1,000 ohms,

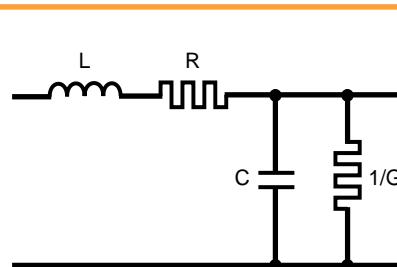

fig. 30: modelling of a propagation support.

Propagation speed approaches that of the velocity of light, i.e. approximately 3×10^8 m/s. This speed can also be said to be equal to 300 metres per microsecond, thus providing an estimation of the distribution along the conductor of a very short term wave front (see fig. 31).

The theory of guided propagation makes it possible to establish that, when a wave propagating along a

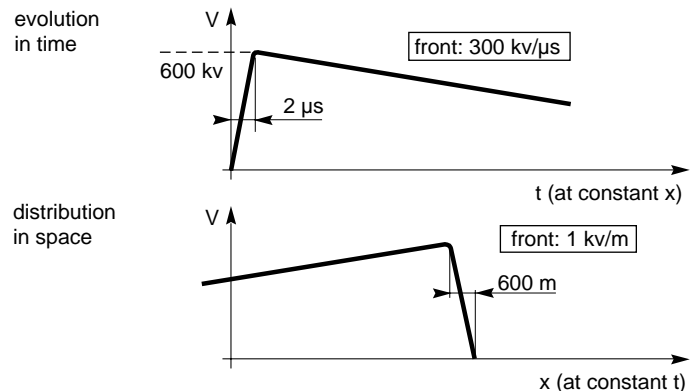

fig. 31: representation in time and space of a lightning wave.

conductor arrives at a point of impedance change, partial reflection and transmission are observed.

If Z_c is the characteristic impedance of the first conductor and Z_a that of the second, the transmission and reflection coefficients are given by:

$$T = \frac{2Z_a}{Z_a + Z_c} \text{ et } R = \frac{Z_a - Z_c}{Z_a + Z_c}$$

The limit values of these coefficients correspond to simple physical cases:

■ $Z_a = 0$ (line closed at the frame): voltage at the point in question is thus zero at all times: this corresponds to a

zero transmitted wave and a reflected wave with a factor -1;

■ $Z_a = Z_c$ (homogeneous conductor): transmission equals 1 and reflection zero;

■ $Z_a = \text{infinite}$ (line open): voltage at the reflection point is given by the superimposition of the incident wave and the reflected wave with a factor + 1. Its maximum value will then be equal to twice the peak of the incident wave. Although there is no propagation in the medium Z_a , the border value is still given by T which also equals 2.

This case results in a high stress at the reflection point and in its vicinity (vicinity in the space distribution sense mentioned above).

The expression «doubling of the voltage wave», frequently used, may lead to confusion by letting people think that the reflected wave is twice as large as the initial wave. It is only at the reflection point that the maximum value observed is twice the value of the incident wave, since this is the only point where the incident wave and the reflected wave join their peaks.

appendix 2: installing a surge arrester

maximum safety clearance

Wave reflection and propagation (see appendix 1) mean that surge arresters only limit overvoltages at their terminals.

The clipped wave retains the dv/dt of its rising front and could develop, by reflection, at the opening point, a voltage twice that of limitation voltage.

As equipment withstand voltage is generally lower than twice the residual voltage of the arrester, there is a maximum clearance not to be exceeded between the arrester and the substation equipment.

Example:

- lightning wave: $300 \text{ kV}/\mu\text{s}$;
- hence a voltage gradient on the line on passage of the rising front of $1 \text{ kV}/\text{m}$;
- MV substation: impulse withstand of 125 kV ;
- surge arrester: residual voltage: 75 kV .

The maximum stress at the open point will be generated by reflection of the wave peak limited by the arrester. This stress will have twice the value of this peak.

In order to keep to the limit of 125 kV of the equipment, the arrester must therefore act at the latest when the incident wave is in its position

$$\text{equals: } \frac{125}{2} = 62.5 \text{ kV}$$

(instant T_0 in figure 32).

As its conduction level (if approximated to the protection level) is 75 kV , intervention is only possible by the superimposition of the reflected wave on the incident wave.

The reflected wave must have reached a value of $75 - 62.5 = 12.5 \text{ kV}$.

The difference between the incident value (62.5 kV) and the reflected value (12.5 kV), i.e. 50 kV , corresponds to the wave front distributed on the return journey between the arrester and the open point. The return distance is thus no more than 50 m , i.e. a maximum protection clearance of 25 m .

Note:

The coefficient 2 does not mean that peak voltage is doubled but refers to superimposition of the incident wave and the reflected wave (see fig. 32).

cabling the surge arresters

A current wave flows off to the earth when an arrester is used for limitation. This results from application of the voltage wave to the characteristic line impedance:

$$\text{line: } I = \frac{U}{Z_c}$$

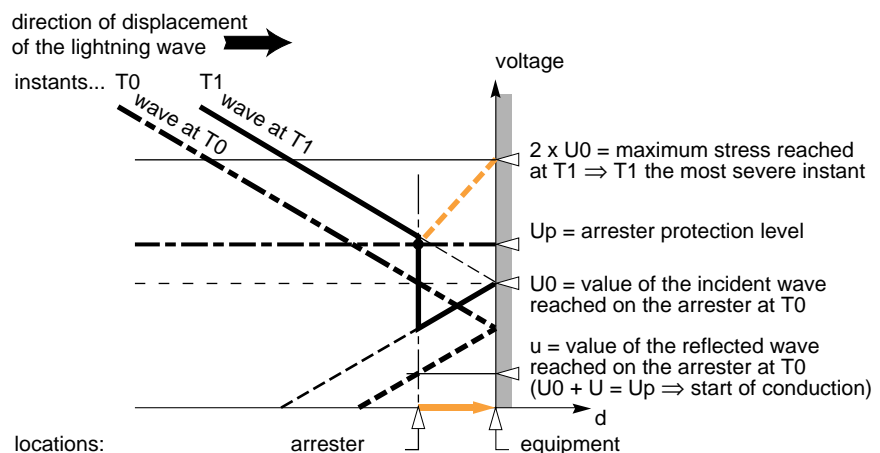
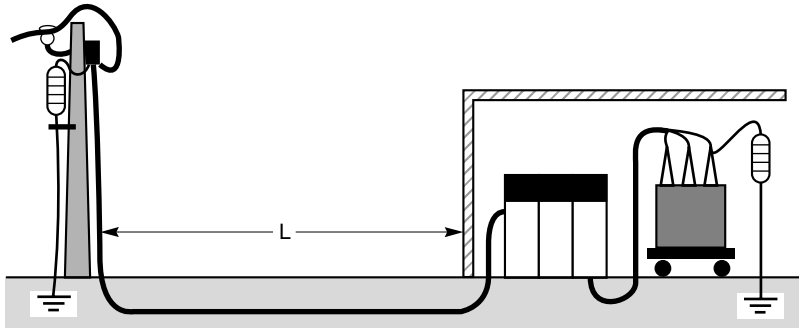

fig. 32: propagation and reflection in the presence of an arrester.



if $L < 25$ m: a surge limiter placed on the pole is sufficient
 if $L \geq 25$ m: a second limiter must be placed at the transformer terminals

fig. 33: position of surge limiters on a substation supplied by an overhead-underground network.

A voltage drop, mainly inductive and which may be high, then occurs in the earthing circuit.

Example:

- current wave: $1 \text{ kA}/\mu\text{s}$;
- earth down-cable inductance: $1 \mu\text{H}/\text{m}$;
- hence $U_L = 1 \text{ kV}/\text{m}$.

If this voltage is not to be added to residual voltage, the proposed equipment must be bypassed at the arrester terminals as regards the «lightning phenomenon».

In practice this consists in connecting as shown in figure 33. If the HV/equipment link is not made on the arrester, conductor length must be as short as possible (see fig. 34).

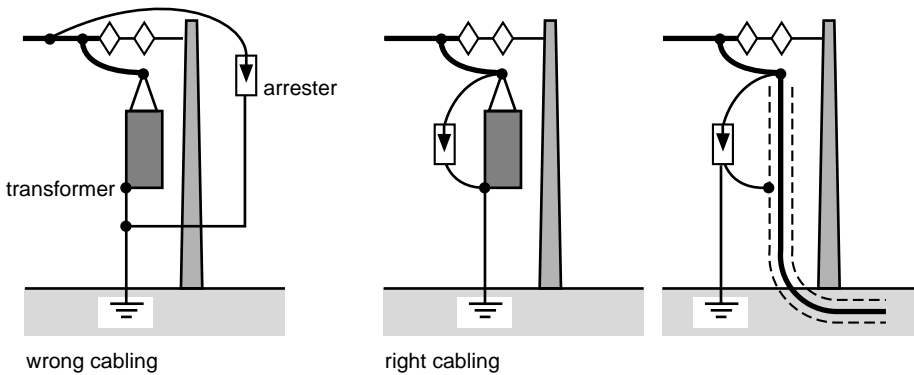

fig. 34: arrester cabling principle: load-arrester connections must be as short as possible transformer.

appendix 3: electricity standards

There are three levels of standards: The following three organisations act at international, European and French level respectively:

- the IEC (International Electrotechnical Commission) produces the «IEC» standards with the participation of 60 countries. Standards are accepted only if opposition is less than 20 %. Its application may give rise to waivers in certain countries.

- the CENELEC (European Electrotechnical Standardisation Committee) produces the «EN» standards and groups 18 countries, mostly European. Application of the standards it votes is mandatory.
- the UTE (Union Technique de l'Electricité) produces the French «NF» standards.

appendix 4: bibliography

Standards

- IEC 60: High voltage test techniques.
- IEC 71-1: Insulation co-ordination: definition, principles and rules.
- IEC 71-2: Insulation co-ordination: application guide.
- IEC 99: Surge arresters.

Merlin Gerin "Cahier technique" publications

- HV industrial network design, Cahier Technique n° 169
G. THOMASSET
- Behaviour of the SF6 MV circuit-breakers Fluarc for switching motor starting currents, Cahier Technique n° 143
J. HENNEBERT

Other publications

- Techniques de l'ingénieur : chapter on «Gaz Isolants».
- Les propriétés diélectriques de l'air et les très hautes tensions. (EDF Publication).
- Principles and procedures of the insulation co-ordination.
KH. WECK.
- Dimensionnement des parafoudres MT pour le réseau EDF (1988).
A. ROUSSEAU (EDF).